

Article number: 2031100M20200B1T
 Description: E+G levelling foot
 GN 31-100-M20-200-B1-T
 Note: T Without nut, Wrench flat at the bottom

Measures

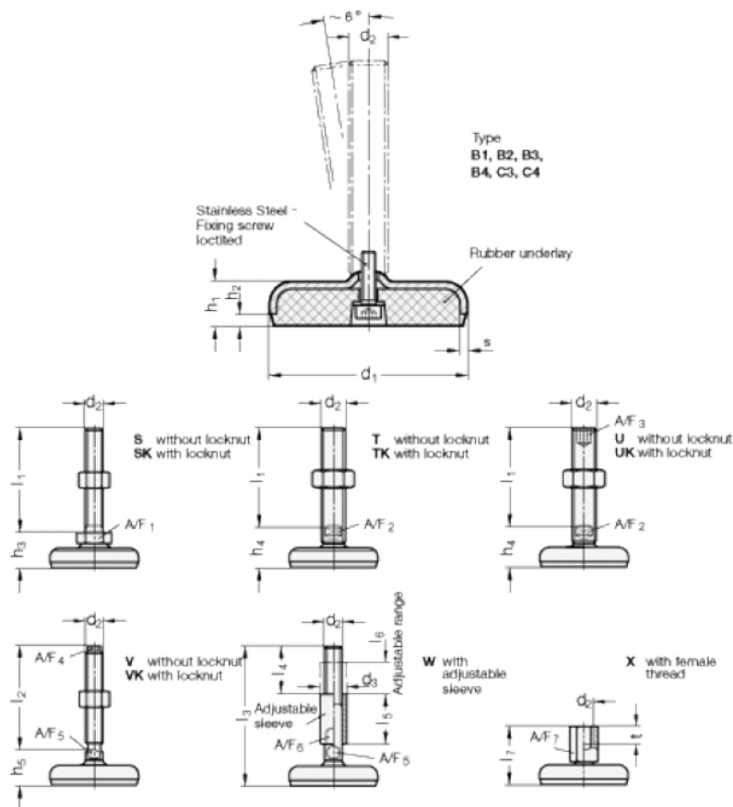

A/F2	= 15
d1	= 100
d2	= 20
h1	= 20
h2	= 6
h4 +4.0/0	= 35
l2	= 200
s	= 3